

# IP/IPX Series Backplane

**Supports PCI and ISA slot on one backplane!**  
**For half-size PCISA series single board computers**

The advantages of using the PCISA card are numerous:

1. Supports standard PISA version 1.0 slot on the IP/IPX series passive backplane.
2. Compatible with all available PCI/ISA cards. IP/IPX backplane is also integrated with the PCISA series card slot.

## Selection Guide

 PAC series wall-mount chassis     4U rack-mount chassis



Model	IP-3S-RS	IP-4S-RS	IP-4S2A-RS	IP-4S4-RS	IP-5SA2-RS
Total Slot	3	4	4	4	5
PCI Slot	2	3	3		4
ISA Slot				3	
PSU Type	AT	AT	ATX	AT	ATX
Chassis	PAC-53GH	PAC-400G PAC-42GH	PAC-400G	PAC-400G PAC-42GH	PR-1500G



Model	IP-6S-RS	IP-6SA-RS	IPX-9S-RS	IP-10S-RS	IPX-13S-RS
Total Slot	6	6	9	10	13
PCI Slot	3	3	8	4	12
ISA Slot	2	2		5	
PSU Type	AT	ATX	ATX/AT	ATX/AT	ATX/AT
Chassis	PAC-1000G	PAC-106G PAC-1000G	PAC-125G	PAC-125G	RACK-305G RACK-360G RACK-3000G

## IP-3S-RS-R40

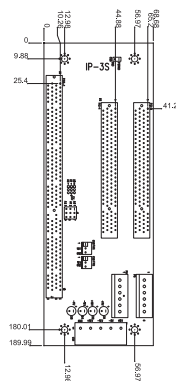
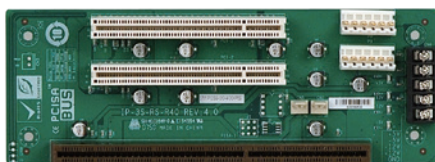

### Ordering Information

IP-3S-RS-R40	3-slot backplane with two PCI slots
PAC-53GH	3-slot half-size compact chassis

## IP-4S-RS-R40

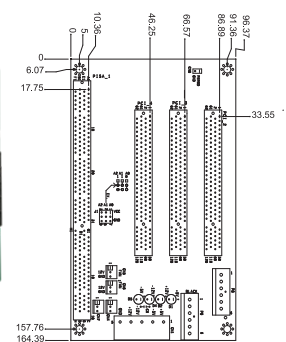
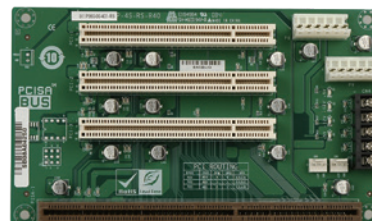

### Ordering Information

IP-4S-RS-R40	4-slot backplane with three PCI slots
PAC-400G	4-slot half-size compact chassis
PAC-42GH	4-slot half-size compact chassis

## IP-4S2A-RS-R40

ATX power

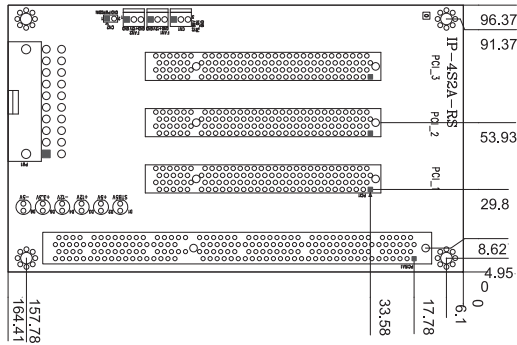
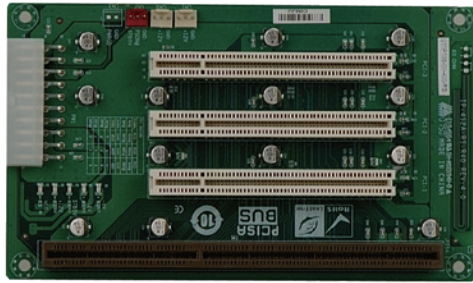

Ordering Information	
IP-4S2A-RS-R40	4-slot backplane with three PCI slots
PAC-400G	4-slot half-size compact chassis

## IP-5SA2-RS-R40

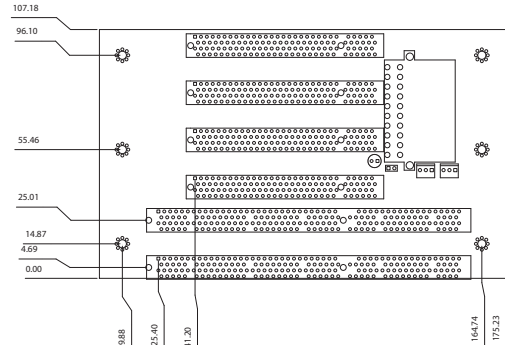
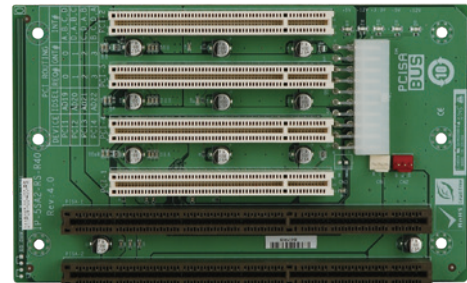

Ordering Information	
IP-5SA2-RS-R40	5-slot backplane with four PCI slots
PR-1500G	5-slot half-size compact chassis

## IP-4S4-RS-R40

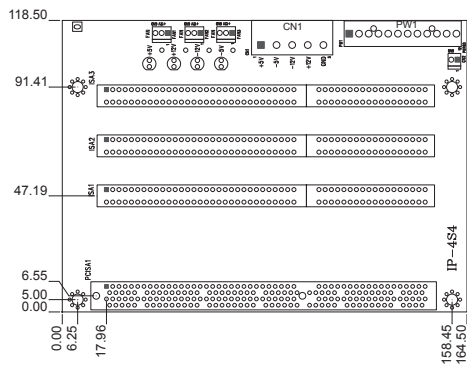
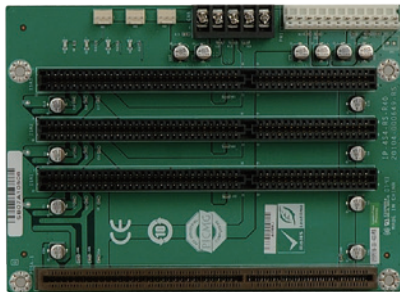

Ordering Information	
IP-4S4-RS-R40	4-slot backplane with three ISA slots
PAC-400G	4-slot half-size compact chassis
PAC-42GH	4-slot half-size compact chassis

## IP-6S-RS-R40

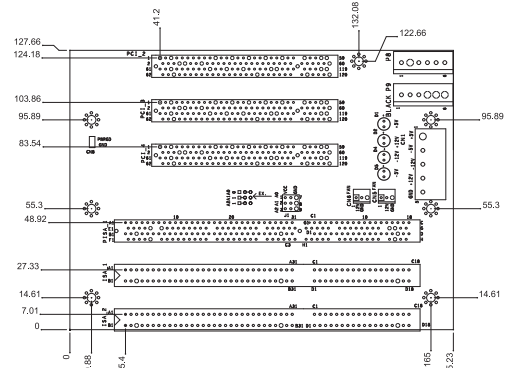
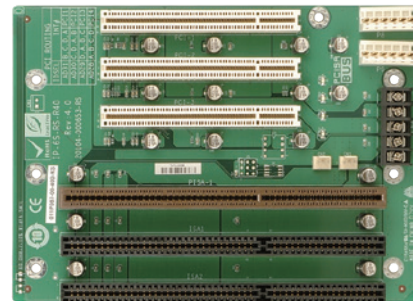

Ordering Information	
IP-6S-RS-R40	6-slot backplane with three PCI slots and two ISA slots
PAC-1000G	6-slot full-size compact chassis

## IP-6SA-RS-R40

ATX power

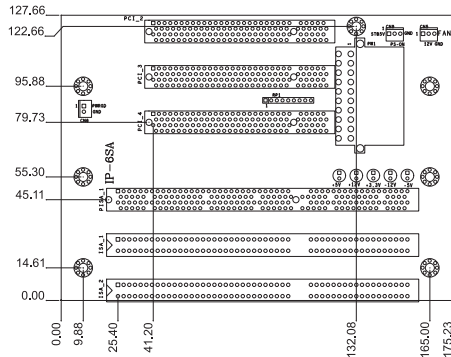
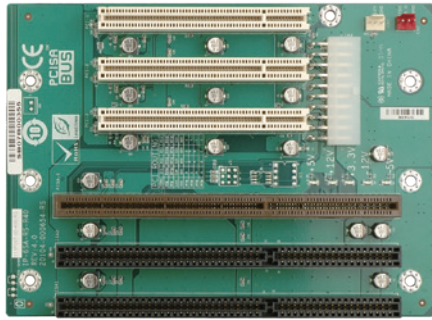

### Ordering Information

IP-6SA-RS-R40	6-slot backplane with three PCI slots and two ISA slots
PAC-106G	6-slot full-size compact chassis
PAC-1000G	6-slot full-size compact chassis

## IP-10S-RS-R40

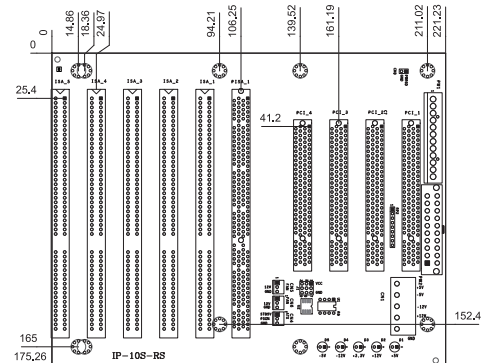
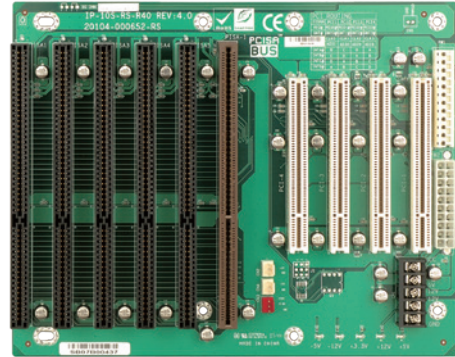

### Ordering Information

IP-10S-RS-R40	10-slot backplane with four PCI slots and five ISA slots
PAC-125G	10-slot full-size compact chassis

## IPX-9S-RS-R41

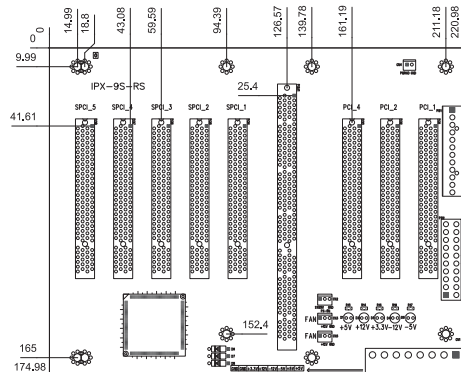
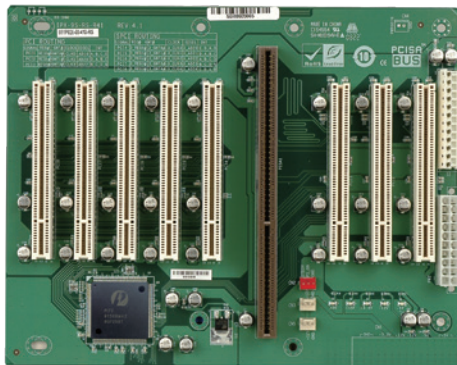

### Ordering Information

IPX-9S-RS-R41	9-slot backplane with eight PCI slots
PAC-125G	10-slot full-size compact chassis

## IPX-13S-RS-R40

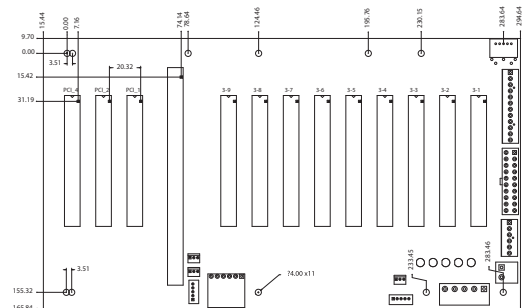
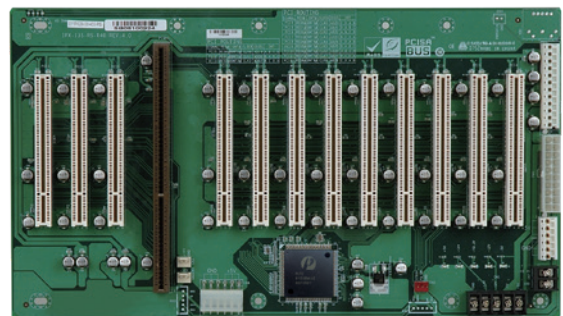

### Ordering Information

IPX-13S-RS-R40	13-slot backplane with twelve PCI slots
RACK-305G	4U 14-slot rack-mount chassis
RACK-360G	4U 14-slot rack-mount chassis
RACK-3000G	4U 14-slot rack-mount chassis